

DESIGNING OF TECHNOLOGICAL COMPLEXES OF HIGHLY EFFICIENT ELECTROMAGNETIC AND THERMOMECHANICAL TREATMENT

**L. M. Akulovich, L. M. Kozhuro,
M. L. Kheifets, and E. Z. Zeveleva**

UDC 621.783.223:658.52.011+536.75

On the basis of studying rational routes and regimes of combined treatment and the generalized block-diagram scheme and layouts of units of flexible production modules, methods of synthesis of technological complexes are proposed that ensure the space and time concentration of operations.

Designing new, more perfect technological processes and equipping them with tools, machines, and means of automation represent complicated problems in machine-building production that have different approaches to their solution and wide ranges of feasible alternatives. Therefore, it is pressing to perform structural synthesis of technological complexes of highly efficient treatment based on parametric optimization of production modules which implement resource-saving processes [1, 2]. For the production of items by means of technological complexes it is expedient to use combined thermomechanical and electromagnetic fluxes of material and energy. Since the processes of surfacing of production objects, up to micronic precision, are mainly of a thermomechanical character, electromagnetic fluxes (due to the simplicity of their formation and convenience of control) are the most adaptive [3].

Generalized Structural Scheme of Flexible Production Modules. A flexible highly reliable production system is subdivided into: 1) actuators (the object of control and drives); 2) information devices (transducers of both the internal and external state of the system); 3) a control system (a computer and microprocessors). Interaction between them is accomplished via the units of integration (the interface) [4, 5].

We will consider the structure of a flexible production module of combined electromagnetic and thermomechanical treatment of workpieces.

For electromagnetic and thermomechanical fluxes [6] the flexible production module is structurally subdivided into two structural constituents, namely, electrical and mechanical parts (Fig. 1). The basic units of the flexible production module of combined electromagnetic and thermomechanical treatment correspond to the following blocks separated in the process of structural synthesis of the technological complex [7]: 1) a mechanism of fastening and movement of a blank; 2) a mechanism of fastening and relative movement of a tool; 3) a mechanism of feeding ferric powder and a working fluid; 4) a mechanism of feeding and relative movement of an electromagnetic feeder, and 5) a d.c. source.

The electrical part of the installation comprises a d.c. source, for which use can be made of welding transformers with a one-period rectification circuit or impulse magnetic thyristor generators; a magnetic system producing a constant magnetic field in the working zone, and a block of control of electromagnets (I); blocks of relative movement of an electromagnetic feeder (II) and of automatic control of a running clearance (III); blocks of control of feed of ferric powder (IV) and a working fluid (V); blocks of relative movement of a tool (VI) and automatic control of treatment forces (VII); a block of blank movement (VIII).

The mechanical part consists of mechanisms of fastening (IX) and relative movement (X) of an electromagnetic feeder consisting of a batching bunker with a vibration mechanism, an electromagnetic coil, and a

Design-Technological Institute of Means of Mechanization and Automation, Minsk, Belarus; Belarusian State Agrarian Engineering University, Minsk, Belarus; Polotsk State University, Novopolotsk, Belarus. Translated from *Inzhenerno-Fizicheskii Zhurnal*, Vol. 73, No. 5, pp. 1080-1087, September–October, 2000. Original article submitted August 24, 1998; revision submitted March 23, 2000.

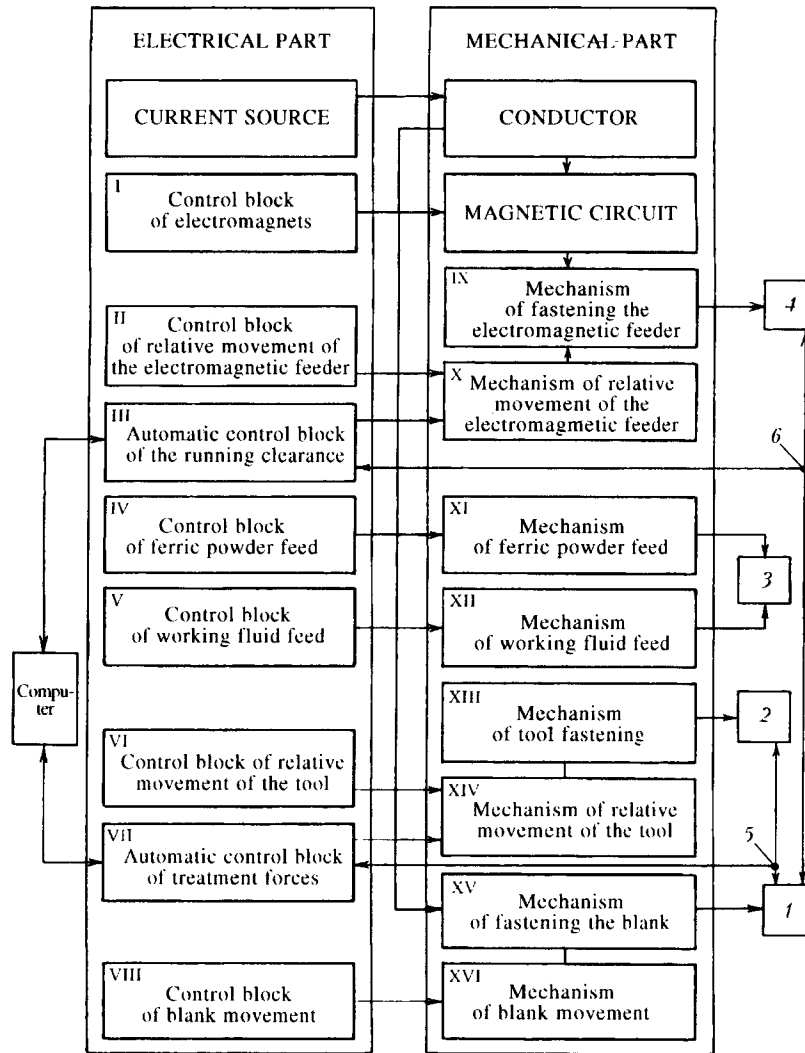





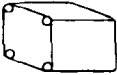
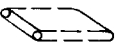

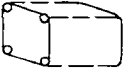



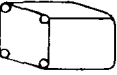



Fig. 1. Generalized block diagram of the flexible production module: 1) workpiece under treatment; 2) tool with a holder; 3) batching and transporting bunker; 4) electromagnet pole tip; 5) treatment-force transducer; 6) running-clearance transducer.

magnetic circuit with a pole tip; mechanisms of feed of ferric powder (XI) and a working fluid (XII) to the treatment zone; mechanisms of fastening (XIII) and relative movement (XIV) of cutting and deforming tools that are fastened at the holders installed on a longitudinal-transverse support; mechanisms of fastening (XV) and movement (XVI) of a blank.

Links of the blocks of the electrical part with the units of the mechanical part which guide the workpiece under treatment 1, holder 2 with a tool, batching and transporting bunker 3, and electromagnetic pole tip 4 are shown on a block diagram of a flexible production module of combined electromagnetic and thermomechanical treatment (Fig. 1). On the diagram the sites of installation of transducers of the treatment forces 5 and running clearance 6 are shown, and their connection to a computer via automatic-control blocks (III, VII) and microprocessors is marked.

The suggested block diagram of the flexible production module contains all the necessary mechatronics constituents [4, 5]: 1) objects of control (1-4) and drives (IX-XVI); 2) transducers (5, 6); 3) mating control units (I-VII). Consequently, the block diagram of any flexible production module of combined electromagnetic

TABLE 1. Fields of the Layout of the Technological Complex

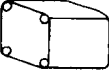
Treatment mode	Notation	Structural formula	FW	FT	WF
Turning	T1	C_h0XYZ			
	T2	ZC_h0XY			
	T3	XZC_h0Y			
	T4	$XYZC_h0$			
Milling	M1	$XYZ0C_h$			
	M2	$XY0C_hZ$			
	M3	$X0C_hZY$			
	M4	$0C_hXYZ$			

and thermomechanical treatment always possesses the indicated elements; this allows the module to operate in the off-line mode for a long time.

For concrete production conditions, different layout diagrams of the blocks and units of the flexible production module can be recommended, but the block diagram of the module remains unchanged.

Layout of the Units of the Flexible Production Module. We will consider the required combination of functional elements for a variety of layouts of a technological complex.

The structural formula of the layout consists of three parts: the central part is a stationary block, the left-hand part pertains to workpiece movement, and the right-hand part is concerned with tool movement [8].













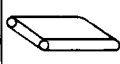

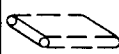

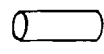
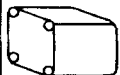

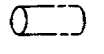

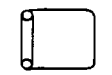

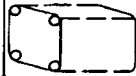

With the principal rotational movement of a workpiece the structural formula of the basic system of the layout for turning (T) has the following form: T1 – C_h0XYZ is workpiece rotation relative to the horizontal axis; the movement of the tool is translational relative to the three coordinate axes.

On implementing a number of forward movements by the block providing rotational movement, we obtain the following varieties of layouts: T2 – ZC_h0XY indicates that the workpiece executes a rotational movement which is translational about the axis of rotation; T3 – XZC_h0Y is, with the exception of movements in layout T2, the block carrying out workpiece movement that performs running-in (feed); T4 – $XYZC_h0$ indicates that the tool is rigidly connected to the stationary block.

With the principal rotational movement of the tool the structural formula of the basic system of the milling layout (M) has the following form: M1 – $XYZ0C_h$ indicates that the tool rotates about the horizontal axis; the movement of the workpiece is translational relative to the three coordinate axes.

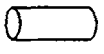
A portion of the translational movements can be imparted to the tool block, and then we have the next three varieties of layouts: M2 – $XY0C_hZ$ indicates that the tool executes rotational and translational movements along the axis of rotation; M3 – $X0C_hZY$ means that the workpiece executes only a transverse translational

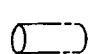
TABLE 2. Fields of the Layout of the Technological Complex

Treatment mode	Structural formula	FW	FT	WF
<i>Without allowance for movements along the Y axis</i>				
Turning	C_h0XZ			
	ZC_h0X			
	XZC_h0			
Milling	$XYZ0C_h$			
	$XY0C_hZ$			
	$X0C_hZY$			
	$0C_hXYZ$			
<i>Without allowance for feed and adjusting movements</i>				
Turning	C_h0Z			
	ZC_h0			
Milling	$Z0C_h$			
	$0C_hZ$			

movement; $M4 - 0C_hXYZ$ indicates that all movements of the technological process, including those of adjustment, are carried out by the tool blocks.

The influence of the layout on the quality of treatment is determined by the structure and design of the technological complex, dimension proportions, and position of the units in space [8, 9].

Loading of the structure by forces in surface shaping occurs within the limits of a certain region of space, which is called the working field of the layout. Within the limits of the working field the technological complex manifests its quality characteristics, namely, rigidity, precision, and so on.

Since surface shaping is accomplished by means of relative movements of the workpiece and the tool, the working field of the layout (WF) is formed as a result of the interaction of the regions of space which can be occupied by the largest workpiece (FW) and the cutting part of the tool of the largest dimension (FT) at all their movements along the coordinates, this yields determination of the spatial boundaries of the working field as a region of intersection of the field of the workpiece and the field of the tool:

$$WF = FW \cap FT .$$

The fields of the workpieces and tools and the working field of the layouts in relation to the variants of the structural formulas of layouts for four modes of movements of actuators described by the functional

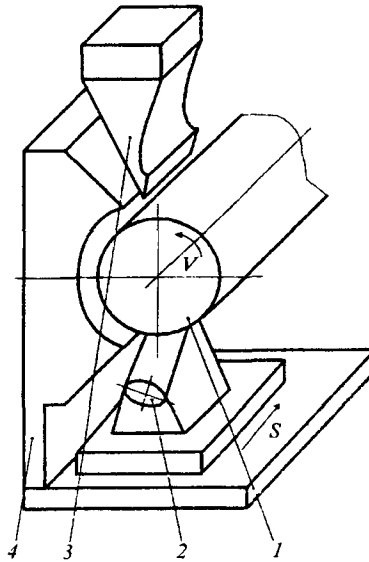

Fig. 2. Layout scheme of the module: 1) workpiece to be treated; 2) tool with a holder; 3) batching and transporting bunker; 4) pole tip of the electromagnet.

elements of the technological complex are presented in Table 1. With the exception of the vertical movement along the Y axis, which is necessary as the adjusting movement in the milling layout, we obtain the types of fields that are used for estimating the quality characteristics of the layout (Table 2). Eliminating the movement of feed of the tool and adjusting the movements of the workpiece, we obtain a minimum of the necessary variants for the working field of the layout of the technological complex for production of a small series of workpieces of machines.

An analysis of the simplest layouts has shown that the working field acquires the form of a straight line. For the recommended methods of hardening and recovery in treatment of bodies of revolution the first variant is the most preferable: the rotation of a workpiece and the movement of accessories, tools, and means of equipment (Fig. 2).

The suggested flexible production module allows automation of small-scale production by providing a flexible passage from the technological to the object principle of operation due to the combination of treatment operations [6].

Rational Routes and Optimal Regimes of Combined Treatment. An analysis of the combined thermomechanical and electromagnetic processes of formation of the surface layer [10-13] in the context of the phenomenon of technological inheritance of the geometric parameters of surface quality [14] makes it possible to recommend the optimal regimes (Table 3) and rational routes of the technological process of treatment of workpieces on the flexible production module of combined electromagnetic and thermomechanical treatment.

In the case where it is necessary to provide a surface roughness R_a of 3.2-6.3 μm , it is suggested to perform electromagnetic facing of ferric powder with surface plastic deformation with a coating hardness of up to 55 HRC [15]. If the hardness exceeds 55 HRC, it is necessary to carry out rotational hardening cutting with electric-arc heating [16].

In the case where a roughness R_a of 0.08-0.10 μm is required, prior to magnetic-abrasive polishing it is necessary to perform diamond grinding up to R_a 1.25 μm [10]. If a roughness R_a of 0.4-0.8 μm is sufficient, then after applying a coating, it is necessary to perform abrasive grinding and magnetic-abrasive polishing [11, 12].

Since for the workpieces of agricultural and motor-vehicle facilities it is sufficient to provide a roughness R_a of 0.4-0.8 μm of the working surfaces, the following combination of technological operations is rec-

TABLE 3. Quality of the Surface Layer of the Workpieces with Wear-Resistant Coatings under Optimal Conditions in Highly Efficient Treatment Processes

Coatings	Technological factors							Quality parameters				
	V, m/sec	S, mmp (A, mm) [*]	I, A	L, mm (τ, sec) [*]	B, T	t, mm (δ, mm) [*]	P, N	K(Q, g/dm ²) [*]	Sm, mm	Ra, μm	HRC	δ _{c.w.} , %
<i>Electric-arc facing with hardening rotational cutting</i>												
65G	0.01	4.00	150	9	—	1.0	—	0.77	3.8	9.5	53.6	8.2
30KhGSA	0.01	4.00	150	12	—	1.00	—	0.72	4.00	9.8	50.2	7.6
<i>Electromagnetic facing with surface plastic deformation</i>												
Fe-V	0.08	0.32	110	—	1.1	—	1400	0.80 [*]	—	6.3	51.2	1.74
Fe-Ti	0.08	0.32	140	—	0.8	—	1250	1.25 [*]	—	6.9	54.0	—
R6M5K5	0.08	0.32	100	—	0.8	—	1350	0.51 [*]	—	6.2	50.7	—
<i>Magnetic-abrasive polishing</i>												
R6M5K5	3.0	1.2 [*]	—	70 [*]	1.2	1.1 [*]	—	1.10 [*]	—	0.07	—	—

^{*}) Technological factors of electromagnetic facing and magnetic-abrasive polishing.

TABLE 4. Technical Data of the Flexible Production Module of Combined Electromagnetic and Thermomechanical Treatment

Technical data	Values
Maximum dimensions of the workpiece under treatment, mm:	
diameter	200
length	250
Maximum rotational velocity of the workpiece under treatment, m/sec	3
Number of electromagnetic coils	2
Maximum current, A:	
applied to the coils	6
discharge current in the running clearance	180
Maximum magnetic induction in the running clearance, T	1.5
Installed power, kW	3.5
Overall dimensions, mm	1800 × 1450 × 1200
Weight, kg	1650

ommended for the flexible production module: electromagnetic facing with surface plastic deformation, rotational cutting with electric-arc heating, abrasive grinding, and magnetic-abrasive polishing.

Rational routes and optimal regimes of combined highly efficient methods of treatment of hardened workpieces (Table 3) have allowed designing a flexible production module.

Use of the flexible production module of electromagnetic and thermomechanical treatment, whose technical data are presented in Table 4, for a complete cycle of operations of the technological process of hardening and recovery of the external surfaces of bodies of revolution such as shafts, axles, and bushes at repair enterprises of the Republic of Belarus has demonstrated high efficiency of the modules under conditions of small-scale production.

The use of the module made it possible to reduce the production staff to two to three workers-operators and to increase the productivity of restoration of workpieces by a factor of 3-4 [6].

The manufacture and application of the multipurpose flexible production modules of combined electromagnetic and thermomechanical treatment under the conditions of small-scale production makes it possible to increase productivity substantially owing to the use of combined treatment, to automatize production based on both the technological and the object principles of organizing, to change the production structure radically due

to its high flexibility, and to organize the production on the principles of self-organization of the technological processes and objects.

Thus, based on the investigations performed, the methods of optimization synthesis of technological complexes of highly efficient treatment of workpieces are developed to include: a) analysis of highly efficient methods of treatment; b) structural synthesis of technological complexes; c) parametric optimization of production modules.

The methods cover the main trends in the development of technological complexes which have been outlined by I. I. Artobolevskii [1] and L. N. Koshkin [2]: 1) use the structural and parametric redundancy in a technological system; 2) apply adaptation of treatment and servicing subsystems; 3) combine the material and information provision of technological complexes.

In designing technological complexes of highly efficient treatment of workpieces, it is proposed [17, 18] to restrict the structural and parametric redundancy of a treatment system by providing self-organization and self-adjustment of functional subsystems of the complex on the basis of space and time concentration of technological operations and transport transitions.

This work was carried out with financial support from the Fund for Fundamental Research of the Republic of Belarus (project 98-181).

NOTATION

X , Y , and Z , translational movements along the x , y , z axes; C , rotational movement about the z axis; h , horizontal position of the axis of rotation; 0 , stationary block; T , turning layout; M , milling layout; WF , working field of the layout; FW , field of the workpiece; FT , field of the tool; V , velocity of principal movement; S , feed rate; A , oscillation amplitude; I , strength of current; L , distance between the spot of heating and the tool; τ , treatment time; B , magnetic induction; t , layer depth; δ , running clearance; P , pressure force; K , additional-to-principal movement velocity ratio; Q , specific productivity of treatment; S_m , mean pitch of roughness; R_a , mean arithmetic deviation of the profile; HRC , Rockwell hardness; $\delta_{c.w.}$, degree of hardening of surface cold working; ϵ_0 , relative wear resistance.

REFERENCES

1. I. I. Artobolevskii and D. Ya. Il'inskii, *Fundamentals of the Synthesis of Systems of Automatic Machines* [in Russian], Moscow (1983).
2. L. N. Koshkin, *Rotary and Rotary-Conveyer Lines* [in Russian], Moscow (1982).
3. L. M. Akulovich, L. M. Kozhuro, M. L. Kheifets, and E. Z. Zeveleva, *Inzh.-Fiz. Zh.*, **72**, No. 5, 971-979 (1999).
4. V. N. Belyakin and V. L. Leshchenko (eds.), *Flexible Automated Production* [in Russian], Moscow (1984).
5. D. A. Bradley, D. Dawson, N. S. Burd, and A. J. Leader, *Mechatronics-Electronics in Products and Processes*, Chapman & Hall (1993).
6. P. I. Yashcheritsyn, L. M. Kozhuro, and M. L. Kheifets, *Vestn. Mashinostr.*, No. 3, 33-36 (1996).
7. P. I. Yashcheritsyn, B. P. Chemisov, M. L. Kheifets, and E. Z. Zeveleva, in: *Current Problems of the Science of Machines* [in Russian], Vol. 2, Gomel' (1988), pp. 117-120.
8. Yu. D. Vragov, *Analysis of Layouts of Metal-Cutting Machines* [in Russian], Moscow (1978).
9. A. A. Matalin, T. B. Dashevskii, and I. I. Knyazhitskii, *Multioperation Machines* [in Russian], Moscow (1974).
10. P. I. Yashcheritsyn, M. T. Zabavskii, L. M. Kozhuro, and M. L. Kheifets, *Izv. Akad. Nauk Belarusi, Ser. Fiz.-Tekh. Nauk*, No. 1, 42-45 (1997).
11. P. I. Yashcheritsyn, M. T. Zabavskii, L. M. Kozhuro, and M. L. Kheifets, *Izv. Akad. Nauk Belarusi, Ser. Fiz.-Tekh. Nauk*, No. 2, 56-59 (1997).

12. P. I. Yashcheritsyn, G. A. Deev, L. M. Kozhuro, and V. S. Shchukin, *Izv. Akad. Nauk Belarusi, Ser. Fiz.-Tekh. Nauk*, No. 4, 36-40 (1993).
13. L. M. Kozhuro, V. S. Shchukin, D. N. Khil'ko, S. L. Kozhuro, and V. L. Shaduya, *Izv. Akad. Nauk Belarusi, Ser. Fiz.-Tekh. Nauk*, No. 1, 62-69 (1997).
14. P. I. Yashcheritsyn, M. T. Zabavskii, L. M. Kozhuro, and L. M. Akulovich, *Diamond-Abrasive Treatment and Hardening of Workpieces in a Magnetic Field* [in Russian], Minsk (1988).
15. M. L. Kheifets, L. M. Kozhuro, A. A. Shipko, et al., *Inzh.-Fiz. Zh.*, **69**, No. 1, 46-57 (1996).
16. M. L. Kheifets, L. M. Kozhuro, A. A. Shipko, et al., *Inzh.-Fiz. Zh.*, **68**, No. 6, 931-943 (1995).
17. P. I. Yashcheritsyn, L. M. Kozhuro, M. L. Kheifets, and B. P. Chemisov, *Dokl. Nats. Akad. Nauk Belarusi*, **41**, No. 3, 121-127 (1997).
18. P. I. Yashcheritsyn, B. P. Chemisov, and M. L. Kheifets, in: *Current Problems of the Science of Machines* [in Russian], Gomel' (1996), pp. 112-113.